



## 10A SMT Point-of-Load Converter



### Features

- High efficiency, 88% (24Vin, 3.3V/10A )
- Excellent thermal performance
- Over-voltage, over-current, short-circuit, and over temperature protection
- Monotonic start-up into pre-biased load
- Fixed frequency operation
- UL 60950-1 2<sup>nd</sup> edition recognized<sup>†</sup>

### Options

- Negative / Positive enable logic
- Output over-voltage protection
- Output voltage tracking/ sequence

### Part Numbering System

NAS	2	□□□	□	□□	S	□	□
Series Name	Input Voltage	Output Voltage	ON/OFF Logic	Output Current	Pin	Electrical Option	Other Option
NAS	2: 9-36 V	Example 000: variable*	P: positive N: negative	Unit: A 10:10A	Regular S: SMT	0: None 1::Voltage Tracking 2:OVP 3:Both VT&OVP 4:Synchronization 5::Both Sync & OVP	5: Open frame 6: Baseplate

\* Consult the factory for semi-custom codes with the output voltage set to a specific value without using an external programming resistor.

<sup>†</sup> UL is a registered trademark of Underwriters Laboratory Inc.



## Absolute Maximum Ratings

Excessive stresses over these absolute maximum ratings can cause permanent damage to the converter. Operation should be limited to the conditions outlined under the Electrical Specification Section.

Parameter	Symbol	Min	Max	Unit
Input Voltage (continuous)	$V_i$	-0.5	38.5	Vdc
Operating Ambient Temperature (See Thermal Consideration section)	$T_o$	-40	85*	°C
Storage Temperature	$T_{stg}$	-55	125	°C

\* Derating curves provided in this datasheet end at 85°C ambient temperature. Operation above 85°C ambient temperature is allowed provided the temperatures of the key components or the baseplate do not exceed the limit stated in the Thermal Considerations section.

## Electrical Specifications

These specifications are valid over the converter's full range of input voltage, resistive load, and operating temperature unless noted otherwise.

### Input Specifications

Parameter	Symbol	Min	Typical	Max	Unit
Input Voltage	$V_i$	9	24	36	Vdc
Input Current	$I_{in\_Max}$	-	-	7	A
Quiescent Input Current (Typical $V_{in}$ )	$I_{in\_Qsnt}$	-	50	70	mA
Standby Input Current	$I_{in\_Stdby}$	-	2	-	mA
Input Reflected-ripple Current, Peak-to-peak (5 Hz to 20 MHz, 12 $\mu$ H source impedance)	-	-	20	-	mA <sub>p-p</sub>
Input Ripple Rejection (120 Hz)	-	-	30	-	dB
Input Turn-on Voltage Threshold	-	-	9.5	-	V

### Output Specifications

Parameter	Symbol	Min	Typical	Max	Unit
Output Voltage Set Point Accuracy ( $V_i$ = Typical $V_{in}$ ; $I_o$ = $I_{o,max}$ ; $T_a$ = 25°C)	-	-2.0	-	+2.0	%
Output Voltage Set Point Accuracy (over all conditions)	-	-2.5	-	+3.5	%
Output Regulation:					
Line Regulation ( full range input voltage, 1/2 full load)	-	-	0.2	-	% $V_o$
Load Regulation (full range load, Typical $V_{in}$ )	-	-	0.3	-	% $V_o$
Temperature ( $T_a$ = -40°C to 85 °C)	-	-	0.2	-	% $V_o$
Output Ripple and Noise Voltage					
RMS	-	-	-	1	% $V_o$
Peak-to-peak (5 Hz to 20 MHz bandwidth, Typical $V_{in}$ )	-	-	2	-	% $V_o$
External Load Capacitance	-	-	-	2,000	$\mu$ F
Output Current	$I_o$	0	-	10	A
Output Current-limit Trip Point ( $V_o$ = 90% of $V_{o,nom}$ )	$I_{o,cli}$	-	170	-	% $I_{o,max}$
Efficiency (Typical $V_{in}$ ; $I_o,max$ , $T_A$ = 25°C)	$\eta$	$V_o=3.3V, I_o=10A$	88	-	%
		$V_o=5V, I_o=10A$	90	-	%
Output Over Voltage trip point		115	125	135	% $V_o$
Output Ripple Frequency	-	270	300	330	kHz
Dynamic Response ( $V_i$ = Typical $V_{in}$ ; $T_a$ = 25°C; Load transient 0.1A/ $\mu$ s) Load steps from 50% to 75% of full load:					
Peak deviation			50		mV
Settling time (within 10% band of $V_o$ deviation)			80		$\mu$ s
Load step from 50% to 25% of full load					
Peak deviation			50		mV
Settling time (within 10% band of $V_o$ deviation)			80		$\mu$ s



## General Specifications

Parameter	Symbol	Min	Typical	Max	Unit
Remote Enable					
Positive Logic					
Logic Low (module OFF)	$V_{ON/OFF}$	0	-	2.5	V
Logic High (module ON)	$V_{ON/OFF}$	5.5	-	36	V
Negative Logic					
Logic Low: (module ON)	$V_{ON/OFF}$	0	-	0.5	V
Logic High (module OFF)	$V_{ON/OFF}$	3.5	-	36	V
Calculated MTBF (Telecordia SR-332, 2011, Issue 3), full load, 40°C, 60% upper confidence level, typical $V_{in}$			12.9		$10^6$ -hour

## Characteristic Curves

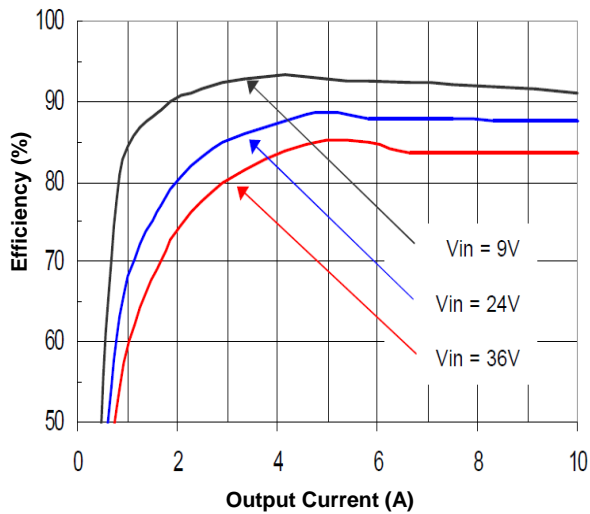

Figure 1(a). Efficiency vs. Load Current (25°C, 3.3V)

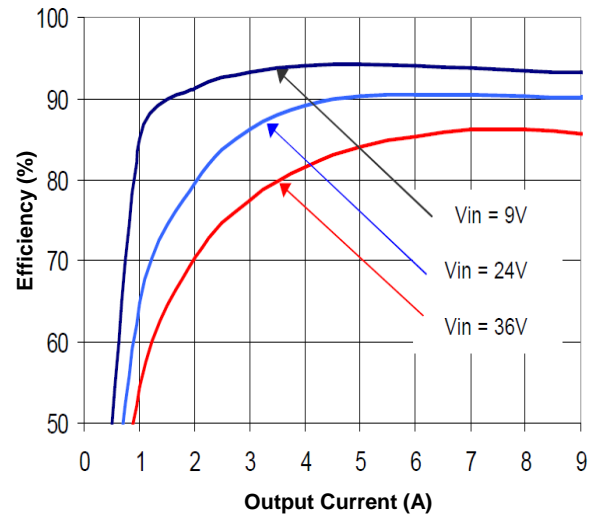

Figure 1(b). Efficiency vs. Load Current (25°C, 5V)

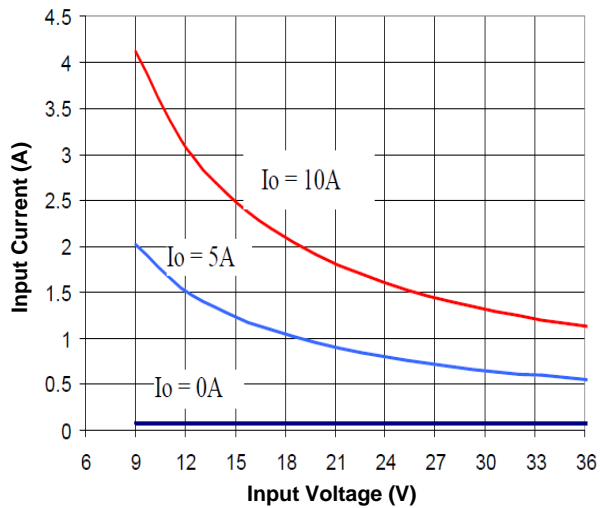

Figure 2. Input Characteristic (5V output)

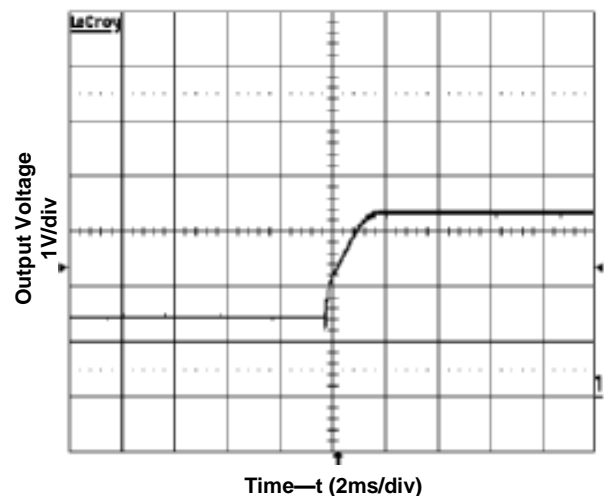
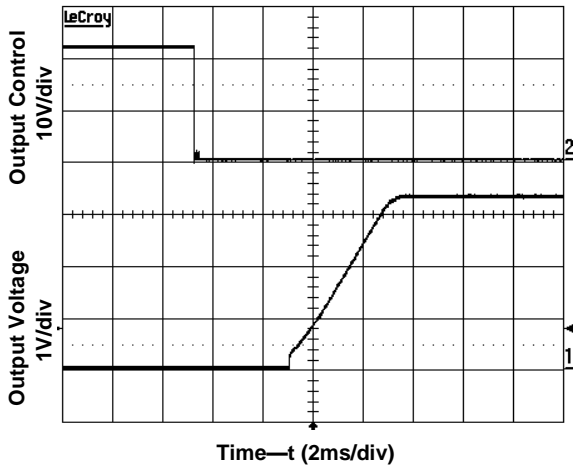
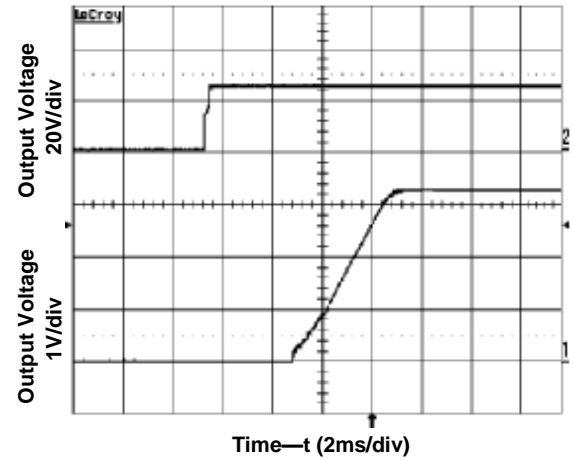

Figure 3. Start-Up with Prebias  
(Input voltage 24V, Output current 0A, Output voltage 3.3V, Prebias 1.8V)



**Figure 4.** Start-Up from Enable Control  
Input voltage 24V, Output current 0A 3.3V.



**Figure 5.** Start-Up from Application of Input Voltage  
(Input voltage 24V, Output current 10A 3.3V)

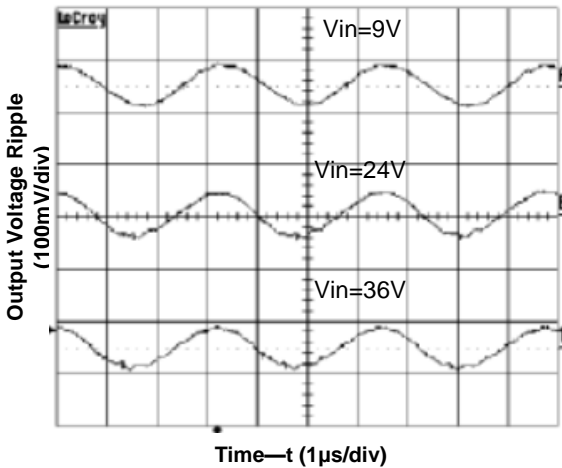

**Figure 6.** Output Ripple Voltage at 5V, 9A Output

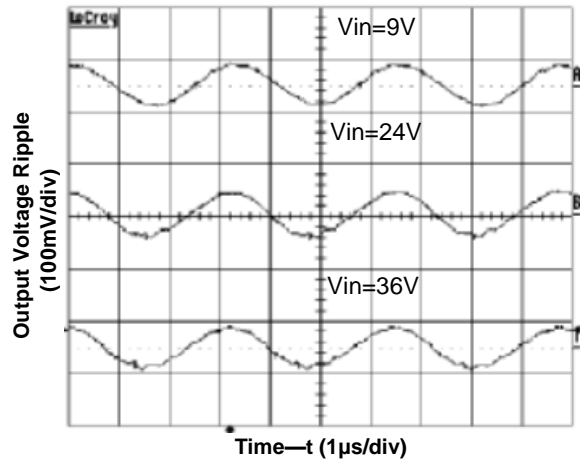

**Figure 7.** Output Reflected Ripple at 3.3V, 10A Output

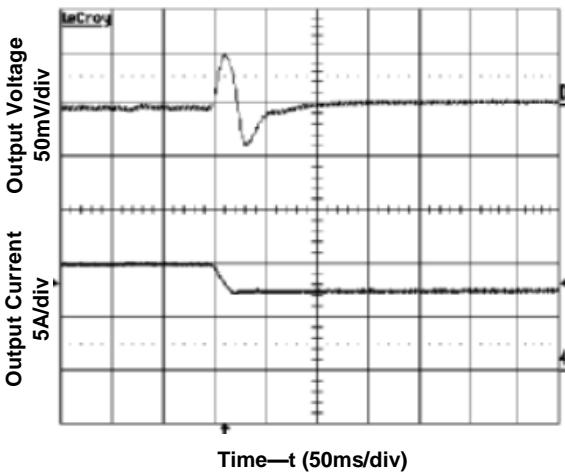

**Figure 8.** Transient Load Response  
Input/output voltage 24/3.3V, Output current 10A->7.5A, Slew rate 0.1A/µs

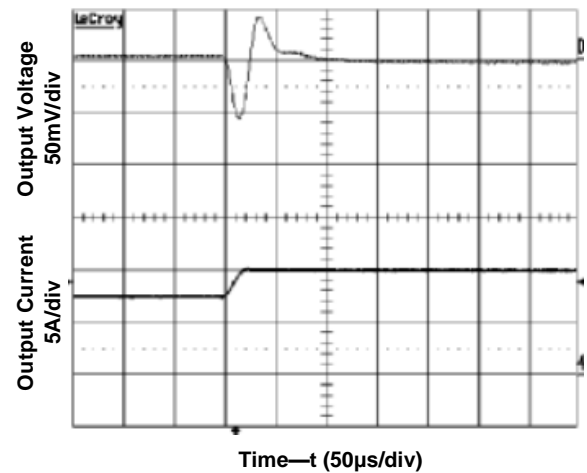

**Figure 9.** Transient Load Response  
Input voltage 24/3.3V, Output current 7.5A->10A, Slew rate 0.1A/µs

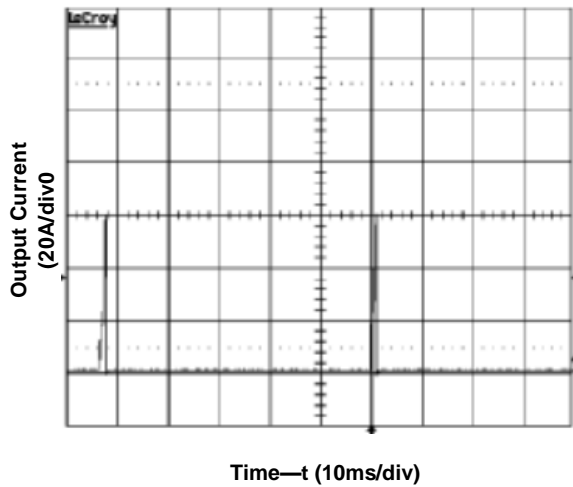

Figure 10. Short Circuit Current.  $V_{in} = 24V$

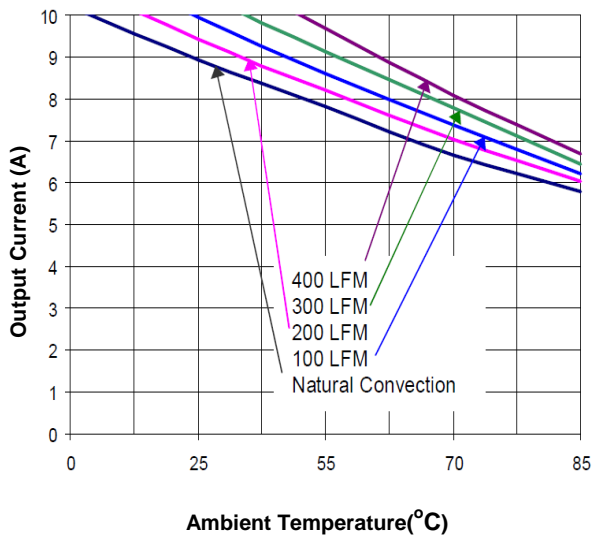

Figure 11(a) . Current Derating Curve for 3.3V Output  
( $V_{in} = 12V$  open frame)

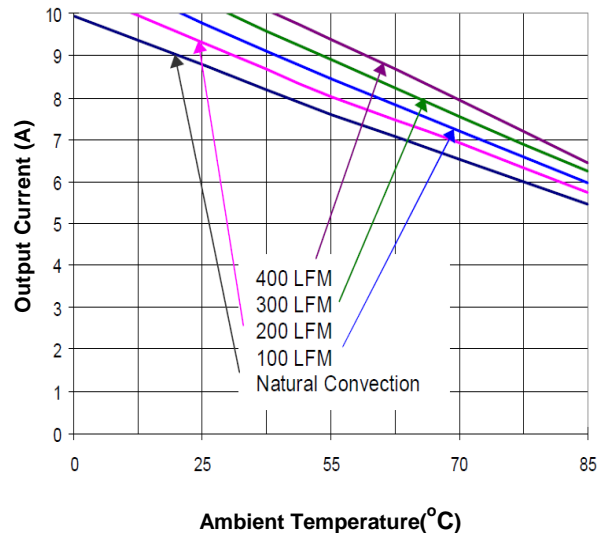

Figure 11(b) . Current Derating Curve for 5V Output  
( $V_{in} = 24V$  open frame)

## Feature Descriptions

### Remote ON/OFF

The converter can be turned on and off by changing the voltage between the ON/OFF pin and Vin(-). The NAS2 Series of converters are available with factory selectable positive logic and negative logic.

For the negative control logic, the converter is ON when the ON/OFF pin is at a logic low level and OFF when the ON/OFF pin is at a logic high level. For the positive control logic, the converter is ON when the ON/OFF pin is at a logic high level and OFF when the ON/OFF pin is at a logic low level. There is no internal pull-up resistor inside the converter. The converter is ON when ON/OFF pin is left open (unconnected).

Figure 12 is the recommended ON/Off control circuit using open collector/drain circuit. Recommended value of the pull up voltage V<sub>pull-up</sub> is Vin. Recommended value of the pull up resistor R<sub>pull-up</sub> is 50K.

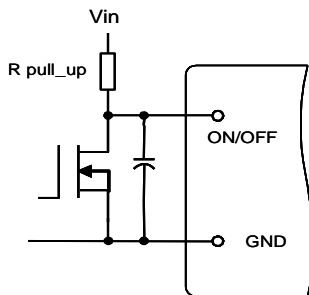

Figure12. Circuit for Logic Control

### Remote SENSE

The remote SENSE pins are used to sense the voltage at the load point to accurately regulate the load voltage and eliminate the impact of the voltage drop in the power distribution path.

The SENSE pin should be connected to the point where regulation is desired. The voltage difference between the output pins must not exceed the operating range of this converter shown in the specification table.

When remote sense is not used, the SENSE pin can be connected to the positive output terminals. If the SENSE pins are left floating, the converter will deliver

an output voltage slightly higher than its specified typical output voltage.

Because the converter does not have remote sense connection for GND, it is important to make sure that the connection resistance and voltage drop between GND pin and the load is small.

### Output Voltage Programming and Adjustment

This series of converters are available with variable output voltages. The output voltage is preset to 3.018V, and can be programmed up to 6V using an external trim resistor connected between the Trim pin and GND pin as shown in Figure 13.

The resistance of the external resistor for trimming up the output voltage can be calculated using the equation below:

$$R_{trim} = \left( \frac{10.5}{\Delta} - 3.48 \right) (k\Omega)$$

Where

$$\Delta = V_o - V_{onom}$$

For variable output models,  $V_{onom} = 3.018$

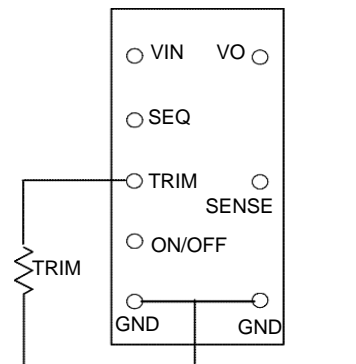

Figure 13. Circuit to Trim Output Voltage.

Because this converter uses GND as the reference for control, R<sub>trim</sub> should be placed as close to GND pin as possible, and the trace connecting GND pin and R<sub>trim</sub> should not carry significant current, to reduce the effect of voltage drop on the GND trace/plain affecting the output voltage accuracy.

When remote sense and trim functions are used simultaneously, please do not allow the output voltage at the converter output terminals to be outside the operating range.



## Input Under-Voltage Lockout

This feature prevents the converter from turning on until the input voltage reaches 8.3V. However, for converters to output higher than 5.5V, the input under-voltage lockout setpoint is higher and the user should contact the factory for further assistance.

## Output Over-Current Protection

As a standard feature, the converter turns off when the load current exceeds the current limit. If the over current or short circuit condition persists, the converter will operate in a hiccup mode (repeatedly trying to restart) until the over-current condition is cleared.

## Thermal Shutdown

As a standard feature, the converter will shut down if an over-temperature condition is detected. The converter has a temperature sensor located within the converter's circuit board, which detects the thermal condition of key components of the converter. The thermal shutdown circuit is designed to turn the converter off when the temperature at the sensor reaches 120° C. The converter will resume operation after the converter cools down.

## Output Over-Voltage Protection

As an optional feature, if the voltage across the output pins exceeds the output voltage protection threshold as shown in the Specifications Table, the converter will clamp the output voltage to protect the converter and the load. The converter automatically resumes normal operation after the over voltage condition is removed.

The over-voltage protection setpoint is 6.25V for the adjustable output model

## Voltage Tracking/Sequencing

An optional voltage tracking/sequencing feature is available with these converters. This feature is compatible with the "Voltage Sequencing" feature (DOSA) or the "Voltage Tracking" feature (POLA) seen in industry standards.

This feature forces the output of the converter to follow (track) the voltage at the SEQ pin on a 1:1

basis. When the voltage at the SEQ pin rises above the set point, the output of the converter will stay at the set point. This feature allows the user to program the output voltage waveform during turn-on and turn-off of the converter by applying a voltage signal of desired shape at the SEQ pin. When using this function, one should pay careful attention to the following aspects:

- 1). This feature is intended mainly for startup and shutdown sequencing control. In normal operation, the voltage at SEQ pin should be maintained higher than the output voltage set point;
- 2). The input voltage should be valid for this feature to work. During startup, it is recommended to have a delay of at least 10 ms between the establishment of a valid input voltage, and the application of a voltage at the SEQ pin;
- 3). The ON/OFF pin should be in "Enabled" state when this function is effective.
- 4). The converter's pre-bias startup is affected by this function. The converter will still be able to start under a pre-bias condition, but the output voltage waveform will have a glitch during startup if this feature is selected

## Design Considerations

The stability of the NAS2 converters, as with any DC/DC converter, may be compromised if the source impedance is too high or too inductive. It's desirable to keep the input source AC impedance as low as possible. To reduce switching frequency ripple current getting into the input circuit (especially the ground/return conductor), it is desirable to place some low ESR capacitors at the input of the converter. Due to the existence of some inductance (such as the trace inductance, connector inductance, filter inductance, etc) in the input circuitry, possible oscillation may occur at the input of the converter. Because of the relatively high input current of low input voltage power converters, it may not be practical or economical to have separate damping or soft start circuit in front of POL converters. A combination of ceramic capacitors and Tantalum/Polymer capacitors are recommended to be used at the input, so the relatively higher ERS of Tantalum/Polymer capacitors can help to damp the possible oscillation.

Similarly, although the converter is designed to be



stable without external capacitor at the output, some low ESR capacitors at the output are desirable to further reduce the output voltage ripple and improve the transient response. A combination of ceramic capacitors and Tantalum/Polymer capacitors at the output usually yields good results.

## Safety Considerations

The NAS2 Series of converters is designed in accordance with EN 60950 Safety of Information Technology Equipment Including Electrical Equipment. The converters are recognized by UL in both USA and Canada to meet the requirements in UL 60950, Safety of Information Technology Equipment and applicable Canadian Safety Requirement, and ULc 60950. Flammability ratings of the PWB and plastic components in the converter meet 94V-0.

The converter's output meets SELV requirements if all of its input meets SELV requirements.

## Thermal Considerations

The NAS2 converters can operate in various thermal environments. Due to high efficiency and optimal heat distribution, these converters exhibit excellent thermal performance.

The maximum allowable output power of any power converter is usually determined by the electrical design and the maximum operating temperature of its components. The NAS2 converters have been tested comprehensively under various conditions to generate the derating curves with consideration for long term reliability.

Thermal derating curves are highly influenced by derating guideline, the test conditions and setup, such as test temperatures, the interface method between the converter and the test fixture board, spacing and construction (especially copper weight, holes and openings) of the fixture board and the spacing board, temperature measurement method, and the ambient temperature measurement point. The thermal derating curves in this datasheet are obtained by thermal tests in a wind-tunnel. The converter's power pins are soldered to a 2-layer test fixture board through 18 AWG wires. The space between the test board and a PWB spacing board is

1". Usually, the end system board has more layer count, and has better thermal conductivity than our test fixture board.

Note that the natural convection condition was measured at 0.05 m/s to 0.15 m/s (10ft./min. to 30 ft./min).

## Heat Transfer

Convection heat transfer is the primary cooling means for NAS1 converters. Therefore, airflow speed is important and increasing the airflow over the converter enhances the heat transfer via convection.

Figures 11 (a) - (b) show the current derating curves under typical input voltage 12V for a few output voltages. To maintain long-term reliability, the module should be operated within these curves in steady state.

Proper cooling in the end system can be verified by monitoring the temperature of the key components. Figure 14 shows the recommended temperature monitoring points. The temperature at these locations should not exceed 120 °C continuously.

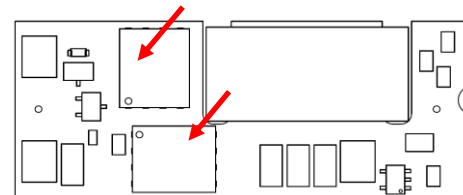

Figure 14. Temperature Monitoring Locations





## Mechanical Diagrams

### Open Frame Module

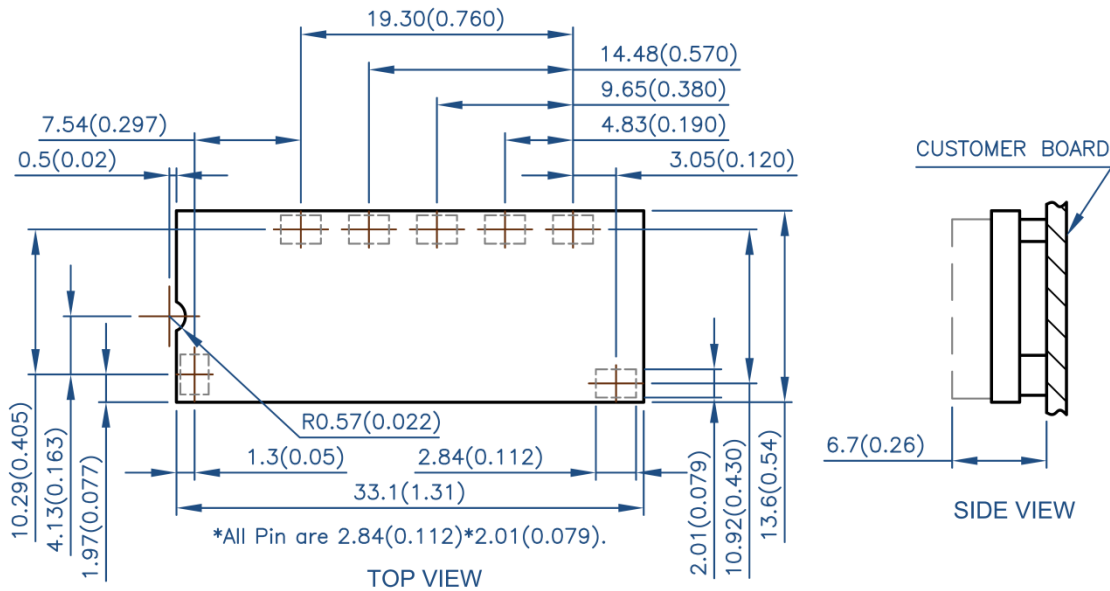

### Base Plate Module

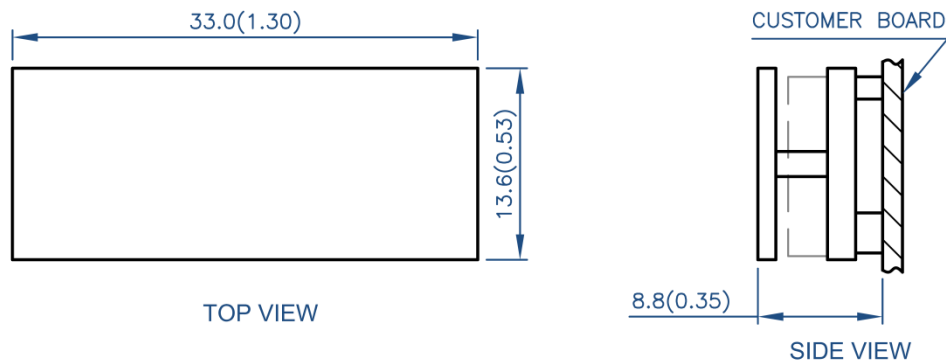

Pin	Name	Function
1	ON/OFF	Remote control
2	SENSE	Remote sense
3	TRIM	Output voltage adjust
4	Vo	Output voltage
5	GND	Connected to Vin(-)
6	SEQ	Tracking/Sequencing
7	Vin	Input voltage

### Notes:

- 1) All dimensions in mm (inches)  
Tolerances: .x ± .5 (.xx ± 0.02)  
.xx ± .25 (.xxx ± 0.010)
- 2) All pins are coated with 90%/10% solder, Gold, or Matte Tin finish with Nickel under plating.
- 3) Weight: 7 g open frame converter  
13 g baseplated converter
- 4) Workmanship: Meet or exceeds IPC-A-610 Class II